

Model 850 Anti-Static Cord



Notes

How it works

Thousands of conductive microfibre filaments concentrate the electric field causing the static charge to be neutralised and flow to earth.

The Anti-Static Cord can be positioned a few millimetres above the material or it may also touch the material, when this is permitted.

Anti-Static Cord must be connected to an earth / ground.

Generally 850 Cord is a more resilient alternative to 801 Anti-Static Tinsel and is used in the same applications. Like Tinsel, when 850 Cord is dirty or contaminated with product it stops being effective and must be replaced.

850 Anti-Static Cord is available in 10m, 25m and 50m rolls.

Applications

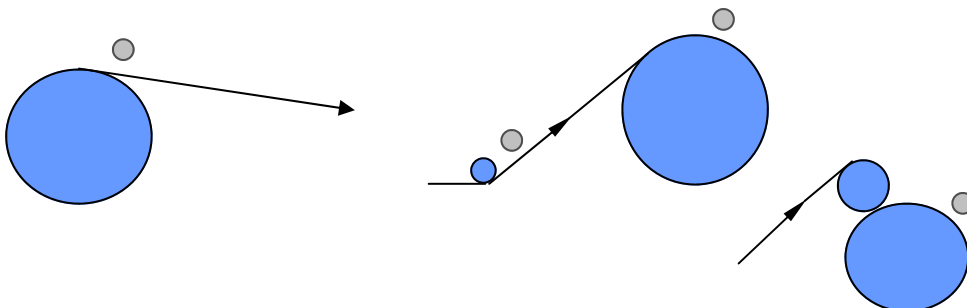

Unwinders

Winders

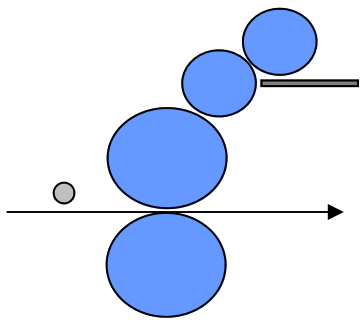

Coaters

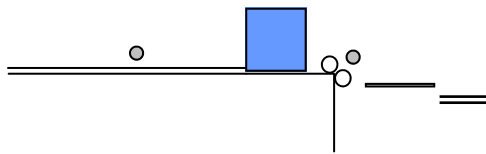

Bagmakers

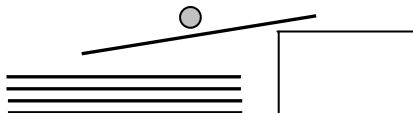

Sheet Feeder

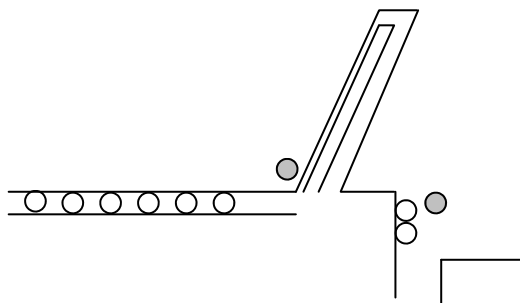

Sheet Folders

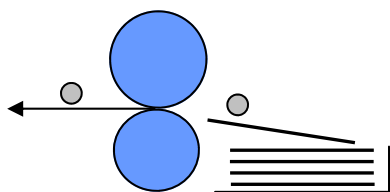

Sheet Cutters

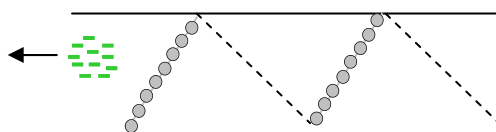

Pneumatic Conveyors

Notes